



"10-65196.3"514

SUPPLY VOLTAGE, total	5V to 40V
OUTPUT CURRENT	SOA
POWER DISSIPATION, internal (PA60EU, 1 amplifier)	19.89W
POWER DISSIPATION, internal (PA60EU, 2 amplifiers) ⁴	31.82W
INPUT VOLTAGE, differential	±Vs
INPUT VOLTAGE, common mode	+Vs, -Vs, -5V
JUNCTION TEMPERATURE, max. ¹	150°C
TEMPERATURE, pin solder - 10 secs max.	220°C
TEMP RANGE STORAGE	-55°C to 150°C
OPERATING TEMP RANGE, case ¹	-40°C to 125°C

4150/413".1-2

PARAMETER	TEST CONDITIONS ^{1,2}	MIN	TYP	MAX	UNTS
INPUT					
OFFSET VOLTAGE, initial			1	15	mV
OFFSET VOLTAGE, vs. temperature	Full temp range		20		μV/°C
BIAS CURRENT, initial			100	500	nA
COMMON MODE RANGE	Full temp range	-Vs		+Vs - 1.3	V
COMMON MODE REJECTION, DC		60	90		dB
POWER SUPPLY REJECTION	Full temp range	60	90		dB
CHANNEL SEPARATION	I _{OUT} = 500mA, f = 1kHz	50	68		dB
INPUT NOISE VOLTAGE	R _S = 100Ω, f = 1 to 100kHz		22		nV/√Hz
GAIN					
OPEN LOOP GAIN	V _O = ±10V, R _L = 2.0KΩ	89	100		dB
GAIN BANDWIDTH PRODUCT	f = 100kHz, C _L = 100pF, R _L = 2.0KΩ	0.9	1.4		MHz
PHASE MARGIN	Full temp range, C _L = 100pF, R _L = 2KΩ		65		°C
POWER BANDWIDTH	V _O (P-P) = 28V		13.6		kHz
OUTPUT					
CURRENT, peak				1.5	A
SLEW RATE		1.0	1.4		V/μS
VOLTAGE SWING	Full temp range, I _O = 100mA	V _S -1.1	V _S -0.8		V
VOLTAGE SWING	Full temp range, I _O = 1A	V _S -1.8	V _S -1.4		V
HARMONIC DISTORTION	A _V = 1, R _L = 50Ω, V _O = .5VRMS, f = 1kHz		.02		%
POWER SUPPLY					
VOLTAGE, V _{SS} ³		5	30	40	V
CURRENT, quiescent total			8	10	mA
THERMAL					
RESISTANCE, junction to case					
DC, 1 amplifier			5.71	6.29	°C/W
DC, 2 amplifiers ⁴			3.57	3.93	°C/W
AC, 1 amplifier			4.29	4.71	°C/W
AC, 2 amplifiers ⁴			2.68	2.95	°C/W
RESISTANCE, junction to air			30		°C/W

- Notes:
1. Long term operation at the maximum junction temperature will result in reduced product life. Derate internal power dissipation to achieve high MTTF.
 2. Unless otherwise noted, the following conditions apply: ±V_S = ±15V, T_C = 25°C.
 3. +V_S and -V_S denote the positive and negative rail respectively. V_{SS} denotes total rail-to-rail supply.
 4. Rating applies when power dissipation is equal in each of the amplifiers.
 5. If -V_S is disconnected before +V_S, a diode between -V_S and ground is recommended to avoid damage.

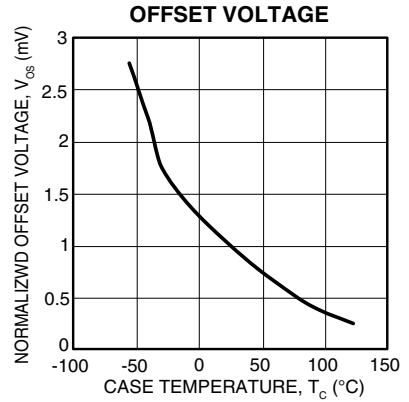
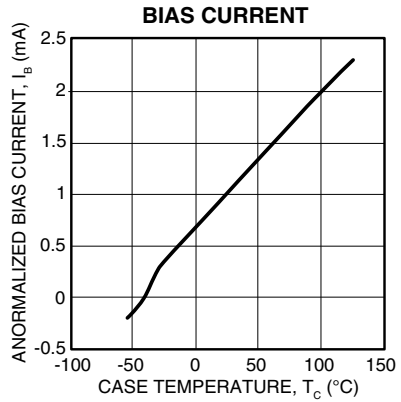
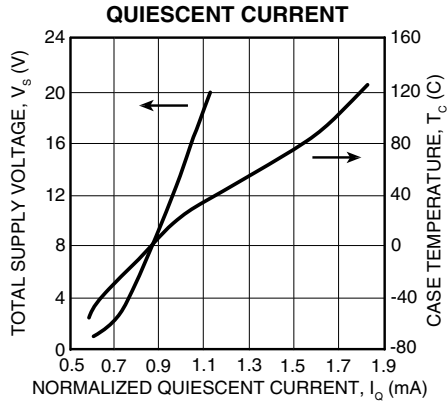

PHASE MARGIN vs. OUTPUT LOAD CAPACITANCE

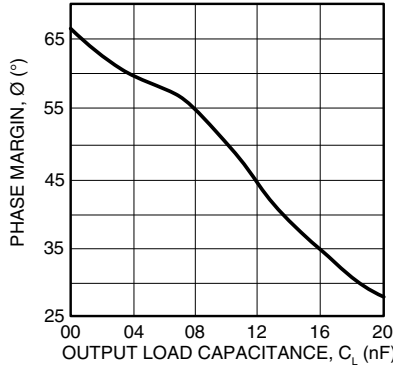

VOLTAGE GAIN & PHASE vs. FREQUENCY

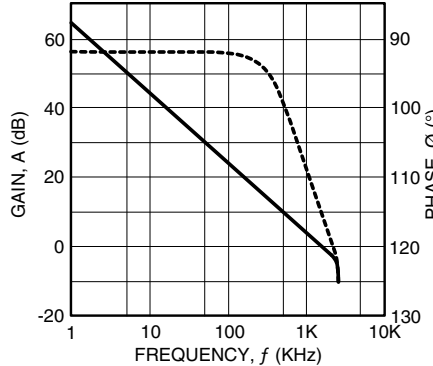

OUTPUT VOLTAGE SWING

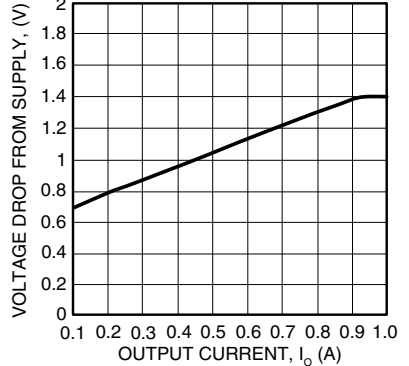

PULSE RESPONSE

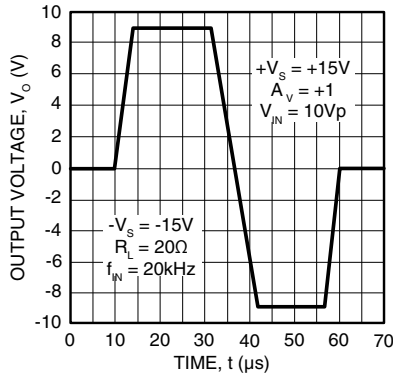

PULSE RESPONSE

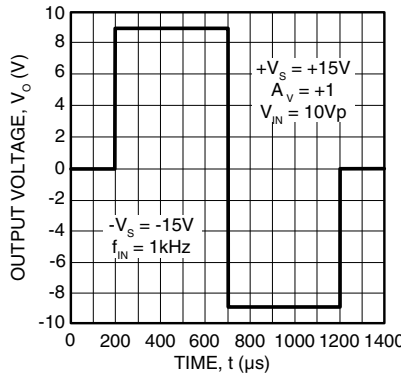

3E

Please read Application Note 1 "General Operating Considerations" which covers stability, supplies, heatsinking, mounting, SOA interpretation, and specification interpretation. Visit www.Cirrus.com for design tools that help automate tasks such as calculations for stability, internal power dissipation, heatsink selection; Apex's complete Application Notes library; Technical Seminar Workbook; and Evaluation Kits.

45

All monolithic power op amps use output stage topologies that present special stability problems. This is primarily due to non-complementary (both devices are NPN) output stages with a mismatch in gain and phase response for different polarities of output current. It is difficult for the op amp manufacturer to optimize compensation for all operating conditions. For applications with load current exceeding 300mA, oscillation may appear. The oscillation may occur only with the output voltage swing at the negative or positive half cycle. Under most operating and load conditions acceptable stability can be achieved by providing a series RC snubber network connected from the output to ground (see Figure 4). The recommended component values of the network are $R_{SN} = 10\Omega$ and $C_{SN} = 0.01\mu F$. Please refer to Application Note 1 for further details.

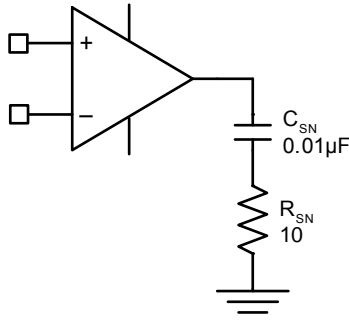

FIGURE 4. R-C Snubber

The SOA curves combine the effect of all limits for this power op amp. For a given application, the direction and magnitude of the output current should be calculated or measured and checked against the SOA curves. This is simple for resistive loads but more complex for reactive and EMF generating loads. The following guidelines may save extensive analytical efforts.

4

The SOA curves combine the effect of all limits for this power op amp. For a given application, the direction and magnitude of the output current should be calculated or measured and checked against the SOA curves. This is simple for resistive loads but more complex for reactive and EMF generating loads. The following guidelines may save extensive analytical efforts.

5)

The PA60EU has a large exposed copper heat tab to which the monolithic is directly attached. The PA60EU may require a thermal washer, which is electrically insulating since the tab is directly tied to -VS. This can result in a thermal impedance RCS of up to 1°C/W or greater.

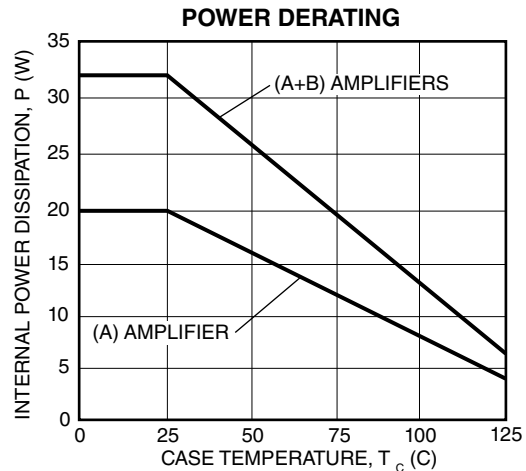
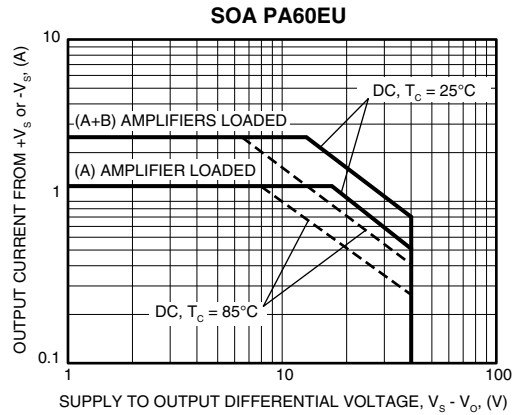

.06/5

1. Always use a heat sink. Even unloaded the PA60EU can dissipate up to .4 watts.
2. Avoid bending the leads. Such action can lead to internal damage.
3. Always fasten the tab of the EU package to the heat sink before the leads are soldered to fixed terminals.
4. Strain relief must be provided if there is any probability of axial stress to the leads.